

DIMENSIONI D'INGOMBRO - OVERALL DIMENSIONS

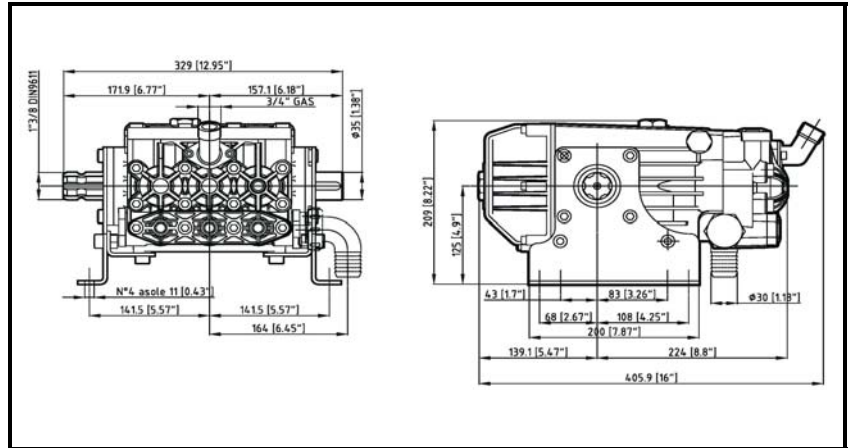

ALBERO POMPA - PUMP SHAFT

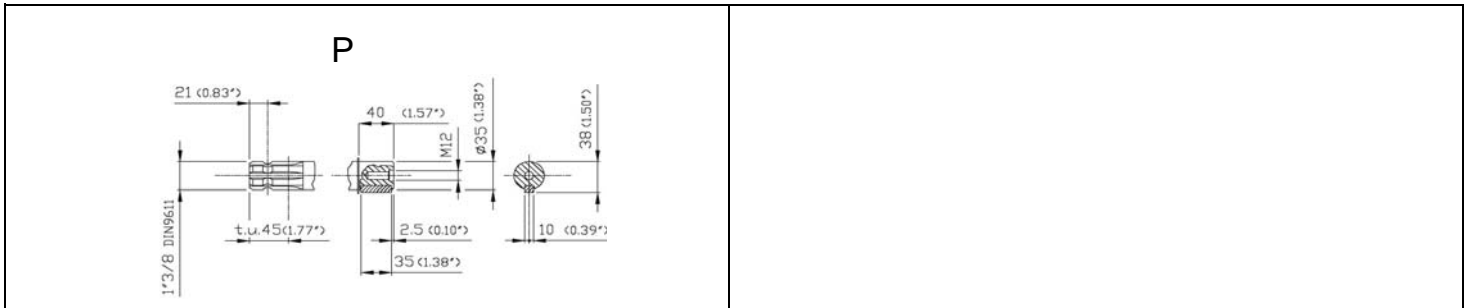

COPPIA DI SERRAGGIO - TORQUE CHART

CODICE - CODE	Q.TY	POS	N-m	Lbr.ft
86.2330.00.2	9	13	10	7,4
86.2730.00.2	6	54	22 (LOXEAL 54-03)	16,2 (LOXEAL 54-03)
86.3562.00.2	8	36	40	29,6
86.3300.00.2	8	38	40	29,6
53.0015.53.2	3	34	35 (LOXEAL 54-03)	25,9 (LOXEAL 54-03)
86.3325.00.2	3	32	28 (LOXEAL 83-54)	20,7 (LOXEAL 83-54)
86.2108.00.2	2	66	10	7,4
86.3212.00.2	8	52	40	29,6
86.3254.00.2	8	67	40	29,6

Tolleranza di serraggio:
Tolerance on torque value: 0/-10%



**INFORMAZIONI UTILI
USEFUL INFORMATION**

LUBRIFICANTE- LUBRICANT:
OLIO MOTORE O SEMIIDRAULICO SAE 30
MOTOR OIL OR SEMI-HYDRAULIC OIL SAE 30

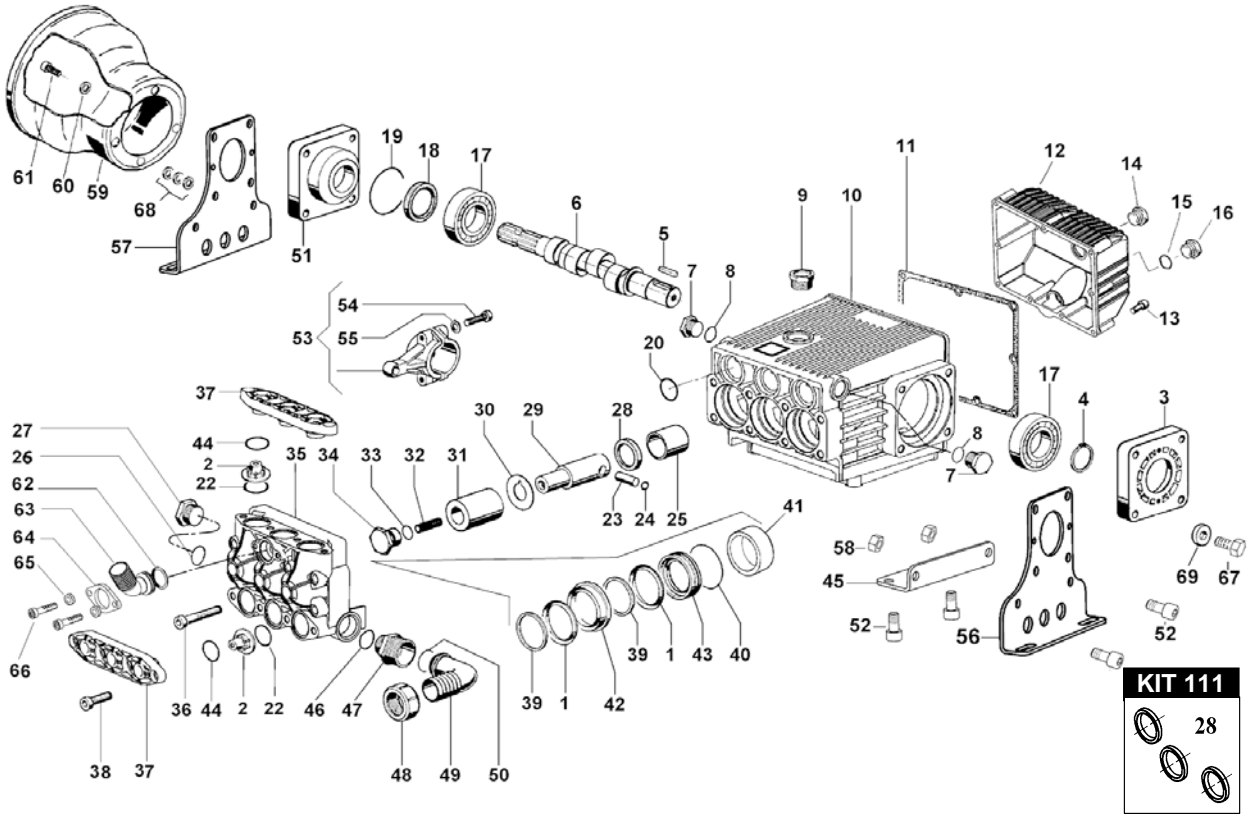

KIT 184

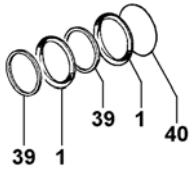

KIT 183

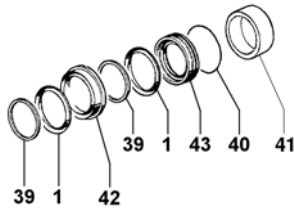

KIT 182

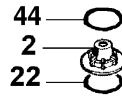

KIT 185

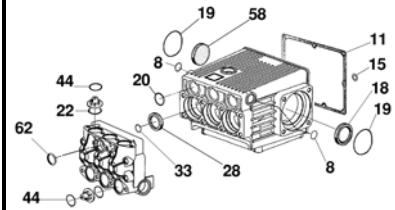

POS.	CODICE PART NO. RÉF.	DENOMINAZIONE - DESCRIPTION - DESCRIPTION	Q.TY	POS.	CODICE PART NO. RÉF.	DENOMINAZIONE - DESCRIPTION - DESCRIPTION	Q.TY
1-KIT183-184	802170002	"V" PACKING DIA.38	6	38	863300002	BOLT TCEI M10x30 UNI 5931	8
2-KIT182	539803973	VALVES ASSY	6	39-KIT183-184	530014322	THRUST RING	6
3	530036092	BEARING COVER DIA.35	1	40-KIT183-184	803209602	O-RING 2.62x47,3	3
4	801264002	CIRCLIP DIA.35	1	41-KIT183	530032482	SPACER GLAND	3
5	806578002	TAB 10x8x35	1	42-KIT183	530031532	FRONT GLAND	3
7	852629002	CAP G.1/2	2	43-KIT183	530030532	REAR GLAND	3
8-KIT185	803187002	O-RING 2.62x17,86	2	44-KIT182-185	803207002	O-RING 2.62x29.82	6
9	060020322	OIL FILLER PLUG	1	45	530036612	BRACKET	2
10	530025092	CRANKCASE	1	46	803206002	O-RING 2.62x28.25	1
11-KIT185	530012722	COVER GASKET	1	47	835089002	NIPPLE G.1"-G.1"1/4	1
12	530033082	CRANKCASE COVER	1	48	820067502	WING NUT G.1"1/4	1
13	862216002	BOLT M6x25 UNI5931	9	49	840560002	90° ELBOW CONNECTOR DIA.30-1,18"	1
14	853515502	OIL SIGHT GLASS	1	50	803219002	O-RING 3x25	1
15-KIT185	824174502	GASKET	1	51	530035092	BEARING COVER 1"3/8 SIDE	1
16	852688002	PLUG G.3/4	1	52	863212002	BOLT TCEI M10x20 UNI5931	12
17	812846002	BEARING 35X72X17	2	53	539800972	CONROD	3
18-KIT185	802143102	OIL SEAL	2	54	862730002	BOLT TCEI M8X30 UNI 5931	6
19-KIT 185	803287002	O-RING 3.53x82,14	2	55	843652002	WASHER D.8,4x13x1,2	6
20-KIT185	803247502	O-RING 3.53x28.17	3	56	530037612	RIGHT SIDE MOUNT	1
22-KIT182-185	803204002	O-RING 2.62x23.81	6	57	530038612	LEFT SIDE MOUNT	1
23	852006242	PISTON PIN DIA.12	3	58-KIT185	802099602	CAP D.52x7	1
24	801080002	CIRCLIP DIA.12	6	59	311468322	PLAIN SAFETY CONE (OPTIONAL)	1
25	804460002	BUSHING	3	60	843685602	WASHER DIA.8,4X17X1,6 (OPTIONAL)	2
26	803206002	O-RING 2.62x28.25	1	61	862475002	BOLT TCEI M8X14 UNI5931 (OPTIONAL)	2
27	852720002	CAP G.1	1	62-KIT185	803218002	O-RING 3x22	1
28-KIT111-185	802133002	OIL SEAL	3	63	311516092	ADJUSTABLE CONNECTOR G.3/4	1
29	530028092	PLUNGER ROD	3	64	311517612	FLANGE FOR ADJUSTABLE CONNECTOR	1
30	530017682	WASHER	3	65	843585002	WASHER D.6	6
31	530018182	CERAMIC PISTON DIA.38	3	66	862108002	BOLT TCEI M6x16 UNI5931	2
32	863325002	BOLT STEI M10x35 UNI5923	3	67	863276002	BOLT TEM10X30 UNI5739	8
33-KIT185	803182502	O-RING 2.62x17,13 VITON	3	68	843696002	WASHER DIA.8,4X18X2 8OPTIONAL)	6
34	530015532	PLUG	3	69	843810973	WASHER DIA.10,5X21X2	8
35	530026092	PUMP HEAD	1				
36	863562002	BOLT TCEI M10x70 UNI5931	8	REPAIR KIT		ITEM NO.s INCLUDED	P.CS.
37	530027092	VALVES COVER	2	KIT 111	539817973	SPARE PARTS KIT	3
				KIT 182	539821973	SPARE PARTS KIT	18
				KIT 183	539823973	SPARE PARTS KIT	24
				KIT 184	539820973	SPARE PARTS KIT	15
				KIT 185	539822973	SPARE PARTS KIT	31